

Smart toilet seat Manual

The Product Model:

- ◆ Thanks for choosing our product.
- ◆ And please read the instructions carefully before properly using.

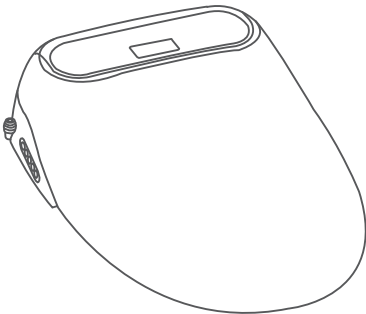

Contents

Overall sketch	1
Safety precautions	2
Function introduction	4
Installation guide	5

Use

Control panel introduction	9
Preparation before use	9
Product use	10
Cleaning and maintenance	16

Appendix

Product specification	19
Packing list	20

Overall sketch

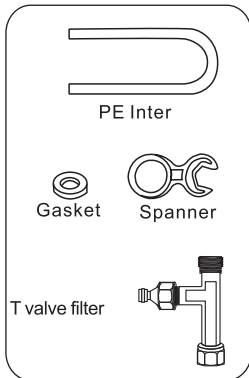
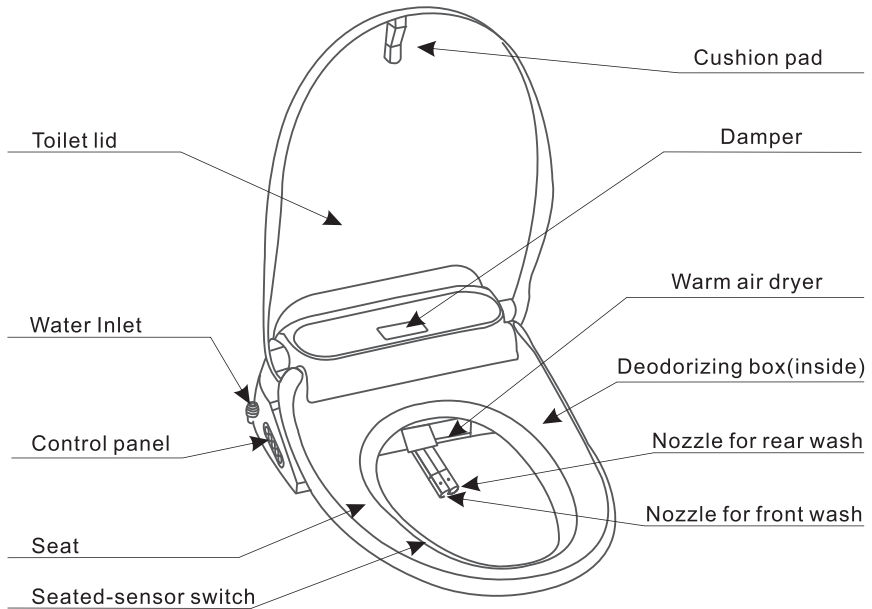

Water pipeline connecting accessories

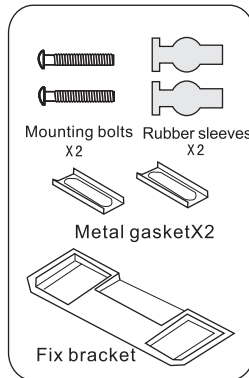

Fix machine parts

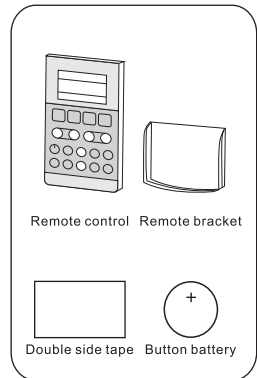

Remote control

Attention:

The specification, design and color of the instruction may differ from the end-product you bought. In the case, you'd better refer to the end-product about the assemblies.

Safety Precautions

All the safety precautions listed can prevent the users from the physical hurts or property losses. Please read all the safety items and warnings, using the product in the right way.



WARNING

Ignoring the sign may lead to serious injury or death.



Don't disassemble, repair, alter the product.

- ◆ All the behaviors above may lead to fire or electric shock.
- ◆ The product needs to be repaired professionals.



Don't immerse the product into the water. If the operating Environment has a quite high humidity, please install scavenging port and seal the attaching plug with rubber.

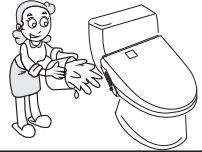

Don't touch the plug with the wet hand.

- ◆ It may lead to electric shock.

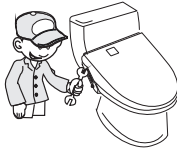

Connect the grounding wire with the product to prevent electric leakage or electric shock.

- ◆ If the grounding wire is not connected with the product, it may lead to electric leakage or shock.
- ◆ The grounding wire needs to be connected with the product by a professional.

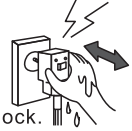

Don't power on before pouring water. The power supply should not be higher than 220-240V

- ◆ It may cause fire.

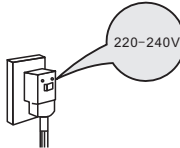

Don't use the loosening plug. The electric wire should not be scratched, damaged, processing, bending, stretching bundling, hang heavy things or clamp.

- ◆ It may cause electric shock or fire.





WARNING

Ignoring the sign may lead to serious injury or death.



Don't stand on the toilet seat cover, seat circle or any other accessories.

- ◆ It may cause break down the product.



Don't open up and close down the toilet seat or toilet cover roughly.

- ◆ It may crack the toilet seat circle or toilet cover and lead to electric leakage.



Don't drag or bend the water pipe.

- ◆ It may make water leakage or no water supply.

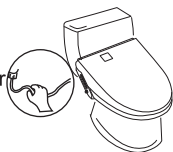

Don't install or leave the remote control near the water.

- ◆ It may break down the remote control.



Preventing damage from freeze.

- ◆ The inlet tube and the inner of the product may be damaged for freezing, and then lead to water leakage.



Attention to the low temperature scalding.

- ◆ After using a long period, please turn off the heat preservation button near the seat circle.
- ◆ Please turn off the button for these groups: children, elders, patients, people unable to adjust the temperature, people with weak skin, people taking sleeping pills, alcoholics, the tired.



Don't put heat instruments beside the substance.

- ◆ It may change the color of the substance or even break down the substance. Please avoid the direct sunshine.
- ◆ Sometimes it may change the color of the plastics. Don't cover the warm air outlet.
- ◆ It may cause fire injury.



The substance cover, seat circle and seat cover are all plastics products. Don't bring fire source like cigarette butt, ashtray near these assemblies.

- ◆ It may lead to fire.

Declaration: In the event that accident occurs as a result of improper usage, company will assume no responsibility.

Function introduction:

Functions	Introduction
Rear wash	Wash posterior
Rear oscillating wash	Rear wash with nozzle swinging
Front wash	Gentle wash for women only
Front oscillating wash	Gentle front wash with nozzle swinging
Temperature control	Adjust seat and water temperature
Water pressure adjustable	Adjust water pressure for washing
Seat sensor	Functions activated by sitting on the seat
Heated seat	Make you feel comfortable and warm at cold winter
Warm air dryer	Dry wash position
Drying intensify control	Adjust drying temperature
Power on/off	Control power
Energy saving	Electricity saving system
Nozzle self-cleaning	Nozzle spray out water for cleaning
Mute anti-collision	Built in damper, close seat slowly
Wash position adjustment	Adjust the wash position
Deodorizer switch	Turn on/off deodorizer
Nozzle self cleaning	Clean nozzle itself
Smart remote control	Allow the user to operate the toilet from a comfortable position
Key lock	Lock the control panel in case of improper operation

Installation Guide

※ Installation environment

- 1、 Before installation, toilet wall, floor tile, ceramic toilet has been completed, bathroom should advance water and 220-240V power socket near by toilet.
- 2、 Water pressure should be between 0.06Mpa(flow)-0.75MPa (Static),water temperature 4℃-35℃.
- 3、 Fozen case, please put the product in a warm place wait to melt then install it.
- 4、 Connect daily-use water pipe only. Connect with recycled water, industrial water conduct, will possibly initiate the infection, and will cause internals jamming or breakdown
- 5、 Please be sure to use incidental T valve and filter.
- 6、 Don't put the power plug into the socket before finished install.

※ Install T valve

- 1、 Lock inlet valve to remove water pipe. See Picture 1.
- 2、 Connect Tvalve, filter and inlet valve. See picture 2.
- 3、 Install flush tank and inlet pipe. See picture 3.

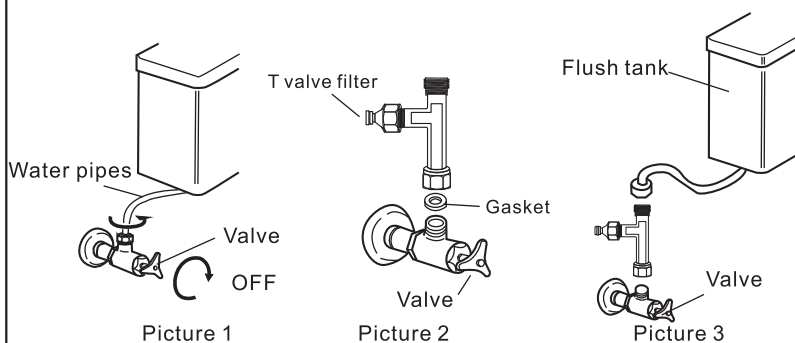

※ Install bidet

① Remove original toilet seat

1. Loss nut.
2. Take out toilet seat.

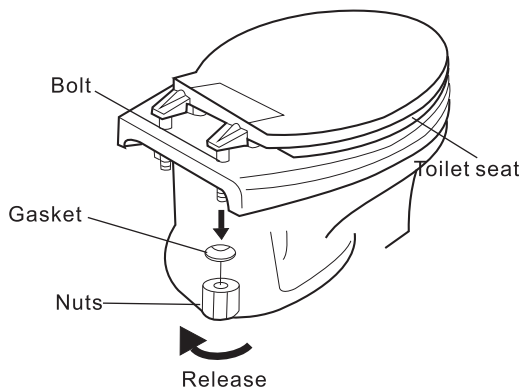

② Install fix bracket

1. put the rubber sleeves into toilet installation hole.
2. put the fix bracket on toilet then start to install it.
3. with the mounting bolts on the bracket fixed the toilet.

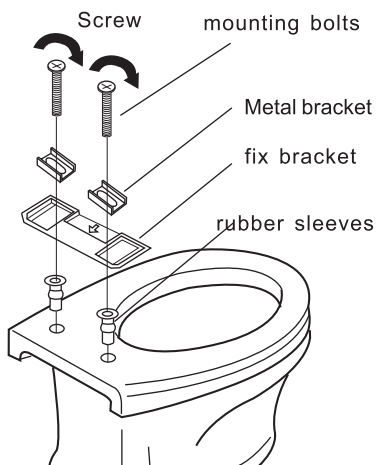

※ The fix bracket can adjust the rang within 130-170mm

※ Install bidet

③ Install bidet

Push the product slip into fix bracket and left bidet to send it into fitter place

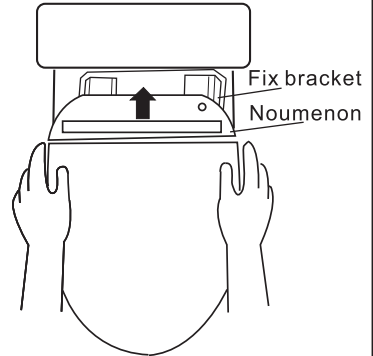

- ※ Notice: please don't forget the power cable between the toilet and bidet.

Be sure the bidet fixed as complete then left bidet to fit it on correct position.

※ connect inlet pipe

① Connect T valve

- 1、Take out clip from connector of T valve.
- 2、Hold on PE Inter to push it towards connector of T valve.
- 3、Reinstall clip to original position.

② Connect bidet

- 1、Take out clip from connector at the side of bidet.
- 2、Hold on PE inter to push it towards connector of bidet.
- 3、Reinstall clip to original position.

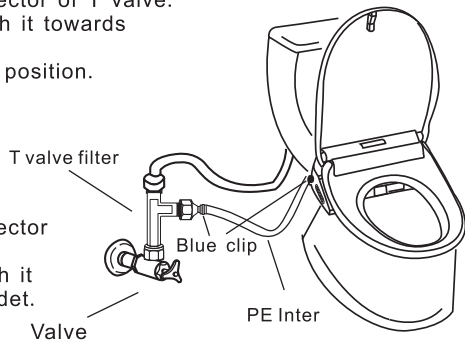

- ※ Turn on inlet valve after connected, please check the connector part leakage or not.

※ Preparation for water supply and Test for operation

1. Insert electric plug into the socket.
2. When the indicator light is on, all indicator lights are shining, at the same time, water flows into the inner water tank, the process will cost about 11s. Then water sprays out from the nozzle. All indicator lights are off with a sound “Di” for once.
3. Press the power button on toilet or on remote controller, then the power indicator light is on, and the toilet is in the condition of work.
4. Adjust temperature of water and toilet seat to appropriate condition
5. Follow the instructions to operate, press buttons as told, and test every action.

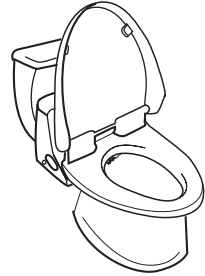

◆ Install the Remote Control Holder ◆

■ Please see below picture

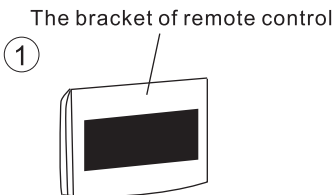

Paste the tape on the backside of remote control

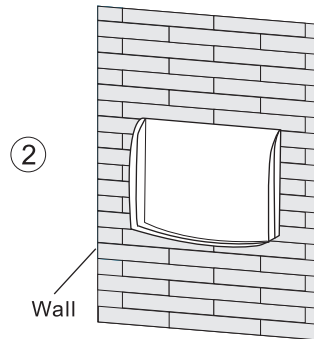

Stick remote control and wall by double side tape

Notice: clean the installation position before pasting and

Press the tape down fully and evenly when positioning.

While after pasting, do not touch the holder within 15 minutes.

Operations

◆ Operation introduction

This product is controlled mainly by remote control, while by control panel subsidiary. Please note below picture is only for illustration that how LED displays in full screen, not the actual interface.

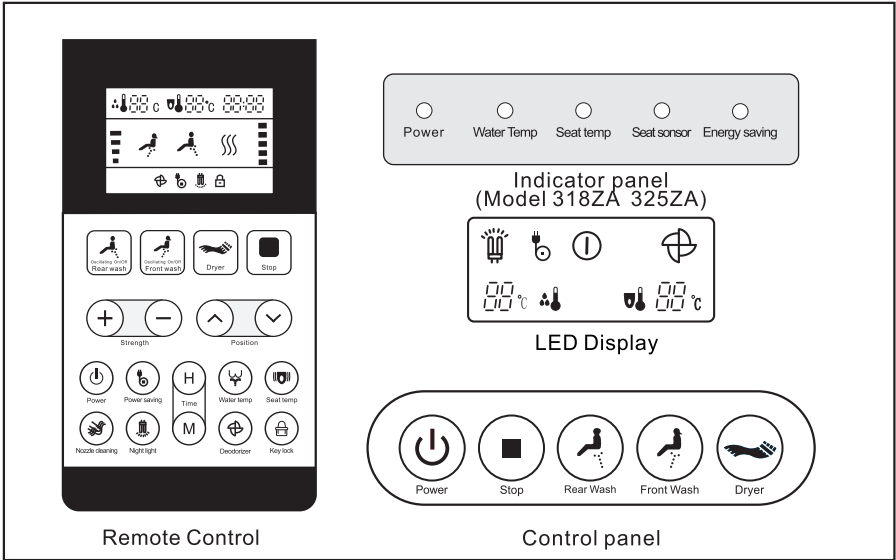

◆ Preparations before Use

1. Ensure the plug is inserted into socket and the indicator light is on.

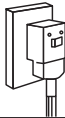

2. Open the water-inlet valve

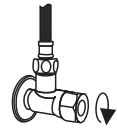

3. Confirm the control panel power indicator is on



4. Press the Power Button on the panel or turn on the power by remote control; also confirm power LED on the toilet is on otherwise it cannot be operated.



◆ Product use manual

1. Sitting on the toilet seat

seated-sensor activated

If air purification is activated, deodorizing function operates automatically.

2. Rear wash

Rear cleansing (Icon as below displays in the screen)



3. Front wash

Feminine cleansing (Icon as below displays in the screen)



4. Water pressure adjusting button

4-position water pressure can be adjusted, use + and – button to adjust.



5. The stop button

Stop rear wash, front wash, or it will stop wash after 2 minutes. (the panel shows)



6. Wash nozzle position adjustable button

5-grade for adjusting the satisfied position to wash by pressing (shows on the up-right panel).

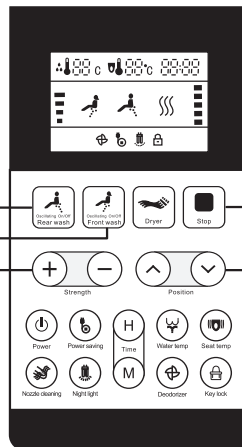

7. Dryer Function

Warm air is blown to dry the area washed by the shower.
(Shows on remote control)



9. Stop

Stop warm air dryer, or it will automatically stop after 4 mins.

8. Warm air dryer adjustable button

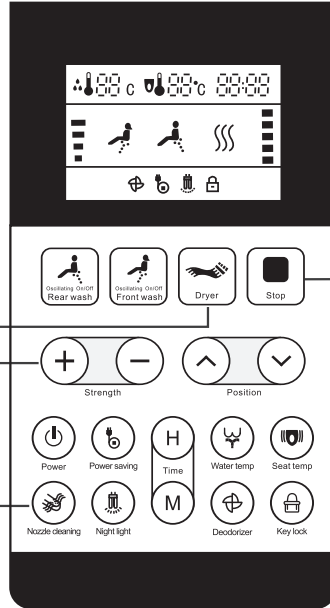

Five-dryer setting for choosing. adjust comfortable air drying by pressing.
(Shows on remote control)





10. Nozzle self-cleaning

Press  then flows out water to clean nozzle.
Nozzle self cleaning is available while no one sits on the toilet.
It will clean nozzle automatically before rear and front wash.

11. Water temperature control

Press  to set water temperature. The temperature shows as a concrete numerical value. When temperature value is between 30-39, water will be heated according to your setting. When temperature value is 00, water will not be heated, Press  to change temperature value, and the value will show on the LED panel of remote controller and LED displayer.

12. Seat temperature control

Press  to set seat temperature. The temperature shows as a concrete numerical value. When temperature value is between 30-39, seat will be heated according to your setting. When temperature value is 00, seat will not be heated, Press  to change temperature value, and the value will show on the LED panel of remote controller and LED displayer.

Reminder

When the remote control displayer and toilet LED screen do not show the temperature, which mean the heating function is turn off.

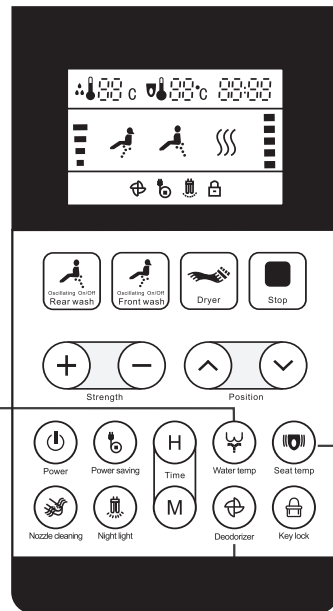



13. Deodorization function

Press  button, turn on deodorization. When you sit on the toilet seat, it will work itself.

Reminder

Under drying, deodorization will stop, after finish drying, it will work again, and last 1.5mins after you leave the seat.

14. Power



Press the  on remote controller. The toilet will be powered off. To power on the toilet. Press the  again, then LED lights.

15. Lighting

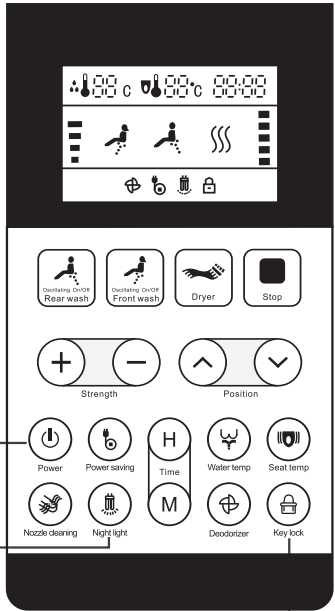
Press  light inside the toilet turns on. The lighting mode will be displayed on LCD panel of remote controller and the LED display. If press this button again, light turn off.



16. Key Lock

Press  The remote controller Will be locked  will show on LCD panel. And all buttons are unavailable. To unlock the remote controller. Press the button again.

17. Power saving

Press  electricity saving mode can be changed in several mode. When turns on, the whole system goes into electricity saving mode in 1.5 minutes. Functions mentioned above can be changed in circulation by pressing this button. The electricity saving mode will show on the LCD panel of remote controller. In auto-saving mode, water temperature and seat temperature remain in 25°C. In 5H-saving mode, water heating and seat heating functions are turned off and will be turned on after 5 hours. Then these functions will work according to original setting.

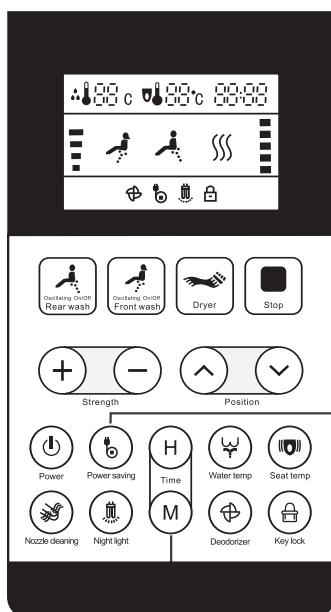

18. Time

Press the  on remote controller, then rectify hour-part of time shows on the remote controller. One plus with one press, the number will change in a circle of 0 to 23.

Press the  on remote controller, then rectify minute-part of time shows on the remote controller. One plus with one press, the number will change in a circle of 0 to 59. changes to 10 hours

Buzzer

Buzzer
Buzz once: Normal operation-receives instructions from the buttons or the remote control
Buzz twice: Auto operates when users stand up
Buzz three times or above: Indicates malfunction or disorders. Buzzing intervals depends.

Indicator light

Indicator light	
power indicator	When the power is on, the indicator light is on. If there is something wrong with flushing components, the indicator light will shine.
seat temperature indicator	When the toilet seat is heating, the indicator light is on. If it is over heated, the indicator light will shine.
water temperature Indicator	When the water is heating, the indicator light is on. If it is over heated, the indicator light will shine.
seat indicator	When seated, the indicator light is on. If water level is low, the indicator light will shine.
energy saving indicator	When it goes into energy saving mode, the indicator light is on.

Warning

1. This appliance is not intended for use by persons (including children) with reduced physical, sensory or mental capabilities, or lack of experience and knowledge, unless they have been given supervision or instruction concerning use of the appliance by a person responsible for their safety.
2. Children should be supervised to ensure that they do not play with the appliance.
3. If the supply cord is damaged, it must be replaced by the manufacturer, its service agent or similarly qualified persons in order to avoid a hazard.

Cleaning and Maintenance

● Cleaning the Toilet Bowl

- ◆ Do not use corrosive solvents to clean the outside of the toilet, such as banana oil, benzene, decolorizer, cleaner, and diluter. Also do not use water to rinsing the equipment as this may cause short circuits, resulting in a fire.
- ◆ Pull out the plug before cleaning in case that plug or the outlet gets wet by water.
- ◆ Scrub the bowl unit gently by soft cloth. If it is very dirty, get the cloth wet and clean the unit by neutral agents.

● Cleaning and Maintenance the Nozzle

- ◆ Press Nozzle Cleaning Button and water sprays out. Press the button a second time then the rear nozzle extends and press again, feminine nozzle extends too. Clean the nozzles with brush.

◆ Replacing the Nozzle (except stainless steel nozzle)

Hold the front end of the nozzle tip and turn it counterclockwise when nozzle extends. Then pull out of it. Replace the tip, insert it into the nozzle and turn it clockwise.

**Do not force the nozzle tip out or bend it.

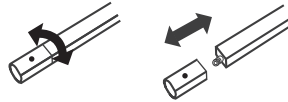

● Cleaning the filter

When the water pressure is too low or insufficient, please clean the filter.

1. Close the shutoff valve and stop water supply.

Notice: Do not remove the filter without closing the shutoff valve. otherwise water will spray out.

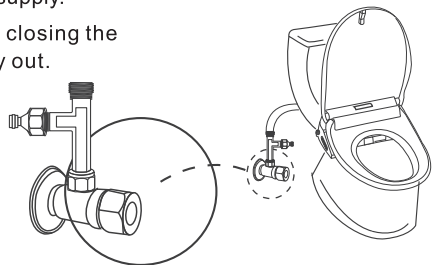

2

Disassemble filter

please use spanner to back-out one touch fitter, take out filter in T valve; turn on the cover of filter to take out filter, please see picture.

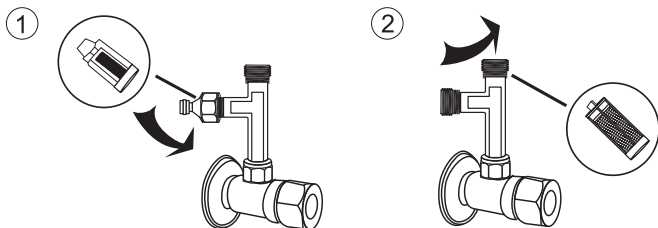

3

Clean

Take out filter to clean the scale via brush.

Please wash it in clear water or brush.

Notice: please don't use detergent to clean it.

Please softly wash the filter net to avoid net deformation

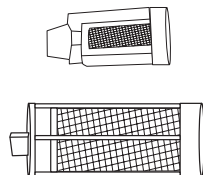

4

Reinstall

Reinstall the net and others in turn.

Notice: tighten up the filter in special spanner, turn on the inlet valve to check it leakage or not.

● Long time no use

- ◆ Please turn off inlet valve and power supplier when out of house as long time or don't use it. Please don't turn off inlet valve and power when room temperature lower than 0°C, your bidet will enter anti-freeze program automatically.

● Daily wash

Disassemble and install

- 1、 Take out plug from socket.
- 2、 Turn off inlet valve.
- 3、 Grip the bidet to pull out, separate it with ceramic toilet.
- 4、 Clean surface of bidet and toilet.
- 5、 Reinstall it after clean bidet and toilet. Grip the bidet to slid it into bracket to hear a sound 'ka' mean in correct position.
- 6、 Make sure the bidet tight fit with the toilet.
- 7、 Turn off inlet valve and put plug into socket.



◆ Replace the remote control battery

◆ Battery installation

1. Use tool to remove remote control and its backside cover.
2. Use tool or coin negatively rotate “+” shape groove, then remove battery cover, do not fall out seal ring.
3. Put button battery into battery hole, upturn battery cathode (with letter side)
4. Put battery cover back, use tool or coin install cover, seal ring should be well installed.
5. Put remote control cover back.

◆ Replace the battery when the remote control is not sensitive.

Notice:

Place battery correctly.

Please take out battery when not in use for a long time .

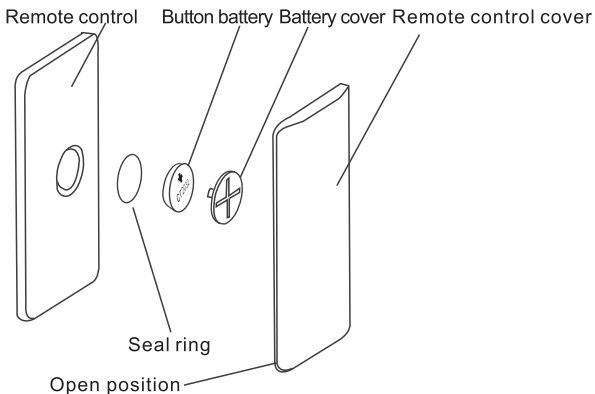

Appendix

Product specification

Rated voltage	AC220-240V 50Hz
Rated power consumption	1520w (When the inflow water is 15 degrees, set the outflow temperature and strength to the maximum.)
Power cord length	1.5m
Cleansing and Flushing	
Water pressure range	0.06Mpa(dynamic)-0.75Mpa(Static) (flow volume is no less than 18L/min)
Water pressure adjustment	Adjustable in 4 levels
Water Temp. Adjustment	Adjustable in 4 levels: 33℃, 36℃, 39℃, (Room Temperature)
Rated power	1520W
Safety Device	Temperature control system; Over-heated protection mechanism; Over-dried protection mechanism; water and electricity isolation system.
General cleansing flow rates	0.5-0.9L/min(Minimum required water pressure:0.15Mpa)
Feminine cleansing flow rates	0.5-0.9L/min(Minimum required water pressure:0.15Mpa)
Seat Heating	
Heater capacity	40w
Surface temperature	Adjustable in 4 levels: 33℃, 36℃, 39℃ (Room Temperature)
Safety device	Temperature control system; Over-heated protection mechanism
Warm Air Dryer	
Heater capacity	200w/250w
Warm air temperature	Adjustable in 4 levels from 32℃ to 62℃
Safety Service	Temperature Reset Switch/Temperature fuse
Deodorizer	
Power consumption	3w
Method	Chemical absorption by deodorizer cartridge
Gross weight	
Dimensions	

◆ Packing List ◆

Dear my user

Please check whether the products are complete after you open the box of toilet.

Product packaging box containing the items are:

A toilet seat

A manual

A spanner

A filter

A rubber gasket

A front wash nozzle(back up)

A rear wash nozzle(backup)

A PEinter

A fix bracket

Two metal gasket

Two mounting bolts

Two rubber sleeves

